

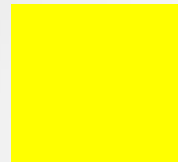

WWW.SINONEO.COM



MAGNETIC GRATE (GRID/GRILL)





ABOUT MAGNETIC GRATES(GRILL/GRIDS)



Magnetic Grate(Grid or Grill) are used for separation of iron particles mixed with dry, granular or free flowing material. Magnetic Grid(Grate or Grill) are made by using stainless steel frames (Round, Square or Rectangular) with Magnetic Rods inside the frame.

These Magnetic Grid(Grate or Grill) are made up of Magnetic Elements which are fitted inside a required size frame. The Magnetic Elements are made up of High Intensity Rare Earth NdFeB Magnets. All the components are made up of Stainless Steel 304/316 material. The overall construction of the Magnetic Grill can also be made as per the customer specification and sizes

The Magnetic Grid(Grate or Grill) are efficiently utilized if contamination is within 1% to 1.5% by weight. For higher levels of contamination Drawer Grills or Multi Drawer Grills should be used.

High Intensity Magnetic Grid(Grate or Grill) having Gauss value of approximately 12,000 Gauss are employed at locations where separation of contamination particles as small as 1 microns is required. These grills have been designed to attract super fine particles from the carrier material.

**10+ YEARS
EXPERIENCE**

**100% QUALITY
GUARANTEE**

**OEM
SERVICE**

**COMPETITIVE
PRICING**



PRODUCT PHOTOS

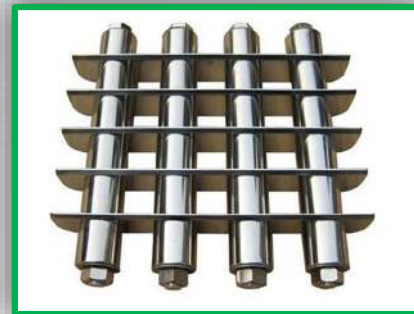



PRODUCT PHOTOS





PRODUCT PHOTOS





SPECIFICATION

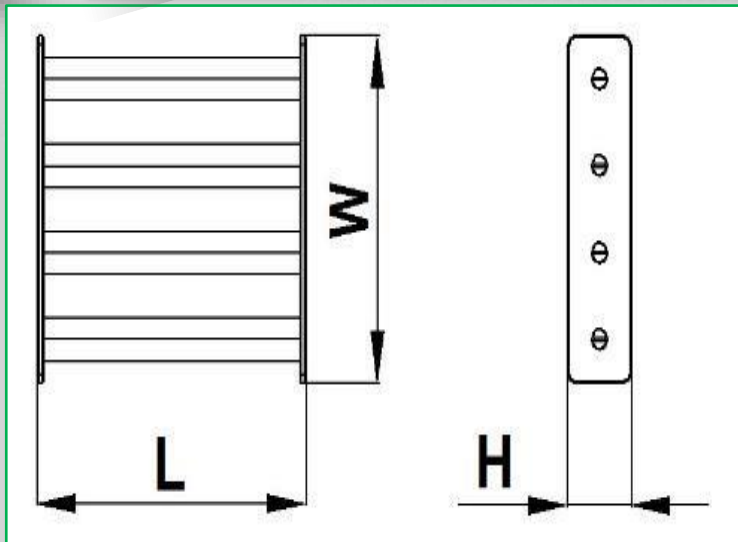

The alternative standard sizes of square shape:

PPS: Any sizes and any shapes, such as rectangle, round, oval, triangle, rhombus or irregular polygon **can be custom made.**

Specification	Size (mm)			No. of rods
	L	W	H	
MG 10/10	100	100	40	2
MG 15/15	150	150	40	3
MG 20/20	200	200	40	4
MG 25/25	250	250	40	5
MG 30/30	300	300	40	6
MG 35/35	350	350	40	7
MG 40/40	400	400	40	8
MG 45/45	450	450	40	9
MG 50/50	500	500	40	10
MG 30/20	300	200	40	4
MG 40/20	400	200	40	4
MG 40/30	400	300	40	6
MG 50/20	500	200	40	4
MG 50/30	500	300	40	6
MG 50/40	500	400	40	8



SPECIFICATION

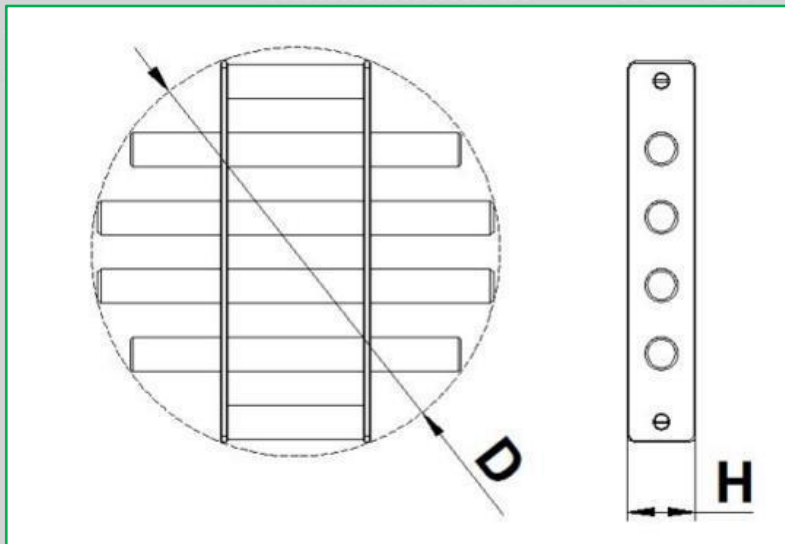

The alternative standard sizes of round shape:

Specification	Size(mm)		No. of rods
	D	H	
MG100	100	40	2
MG150	150	40	3
MG200	200	40	4
MG250	250	40	5
MG300	300	40	6
MG350	350	40	7
MG400	400	40	8
MG450	450	40	9
MG500	500	40	10

PPS:Any sizes and any shapes, such as rectangle, round, oval, triangle, rhombus or irregular polygon **can be custom made.**



MAGNETIC STRENGTH



Per customers' requirement. The highest is up to 12, 000GS (1.2T).

Following is the relationship between diameter, magnetic strength and Maximum Operation Temperature for reference:

	0.25T	0.5T	0.7T	0.9T	1T	1.1T	1.2T
Φ 19 (0.75")	√ EH	√ EH	√ EH	√ H	√ M	-	-
Φ 22 (0.85")	√ EH	√ EH	√ EH	√ H	√ M	√ N	-
Φ 25 (1.00")	√ EH	√ EH	√ EH	√ SH	√ H	√ M	√ N
Φ 32 (1.25")	√ EH	√ EH	√ EH	√ SH	√ H	√ M	√ N
Φ 38 (1.50")	√ EH	√ EH	√ EH	√ UH	√ SH	√ H	√ M
Φ 50 (1.75")	√ EH	√ EH	√ EH	√ UH	√ SH	√ H	√ M
Φ 76 (3.00")	√ EH	√ EH	√ EH	√ UH	√ UH	√ SH	√ H
Φ 100(4.00")	√ EH	√ EH	√ EH	√ UH	√ UH	√ SH	√ H

Remarks:

(1)."√"means it can be manufactured on the condition of the diameters listed in the table."- "means can not be manufactured.

(2). The related Max working temperature from different series.

H series: <=120

SH series: <=150

UH series: <=180

EH series: <=250

(3).Round and square are both available

(4). SS304,SS316 and SS316L stainless steel type are available

(5). Magnetic bar size can be custom made .Max length of is 2500mm when diameter is 25mm.

(6). Various end design are available ,such as Nail head ,thread hole ,double screw bolt ,etc .





PACKING

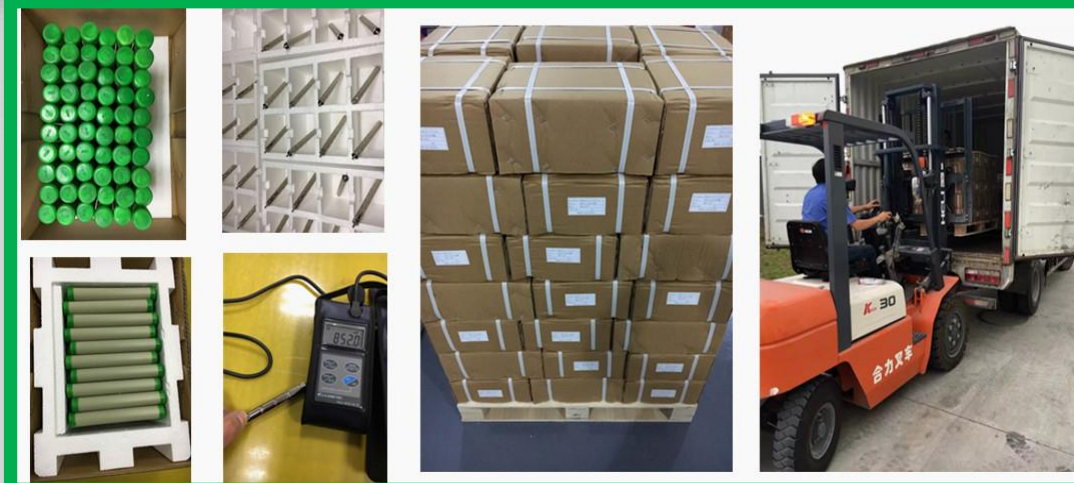

Packing of our products:

1. Sea shipment : strong cartons and then packed in strong wooden cases.
2. Air shipment: well shielded cartons for magnetism inspection.

Our Shipping ways:

1. Express courier, TNT, Fedex, DHL, UPS for your choice.
(1), Ship door to door. You can provide your express account for the freight payable at destination. (2), Delivery time: 3-7 days
2. Air cargo , shipping to your nearest airport.
(1), If you choose this way, please provide us your nearest airport. (2), Delivery 5-15days. (3), Suitable for cargo over 45 kg
3. Sea cargo, shipping to your nearest port.
(1), If you choose this way, please provide us your nearest port and zip code. (2), Delivery approximately 30 days.
(3), This type of shipping is suitable for cargo over 200KGS, or have big volume.



APPLICATION



PHARMACEUTICAL INDUSTRY



BATTERY INDUSTRY



PIGMENT INDUSTRY



WATER TREATMENT INDUSTRY



LIQUID/HYDRO-MATERIAL SEPARATION

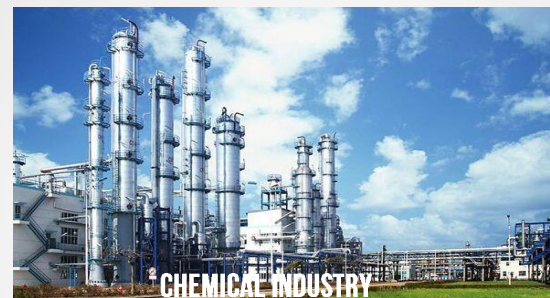

CHEMICAL INDUSTRY



PLASTIC INDUSTRY

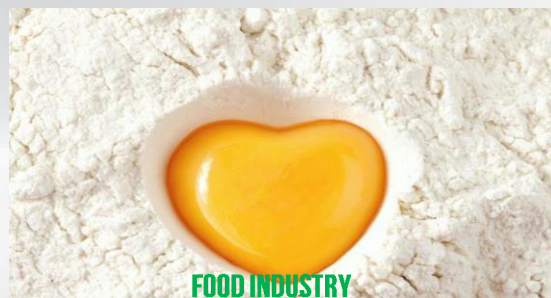

FOOD INDUSTRY



CERAMIC INDUSTRY



OUR ADVANTAGE



1

100% Quality & Best Service Guarantee

3

Quick Delivery Time

2

Experienced Staff

4

Competitive Price



OEM are welcomed, samples is available, small orders accepted.

Let Us Assist You!

Our magnet experts will help you get exactly what you need - custom or stock - in record time with great quality at a very competitive price.



CONTACT US



SCAN TO VISIT OUR WEBSITE

SINONEO MAGNETS CO., LTD.

ADD:NO.580,HENGTONG ROAD,SUZHOU, CHINA(215000)

FACTORY:CICHENG INDUSTRIAL ZONE,NINGBO,CHINA(315000)

PHONE: +0086-159 0650 8736 0086-574-8266 2106

WEBSITE:WWW.SINONEO.COM

EMAIL: SALES@SINONEO.COM

SKYPE:WANGGL503 WECHAT:15906508736